

Operating manual of MaxProAir

1. Product

MaxProAir

2. Intended Use

This MaxProair is intended for inflating/deflating Dunnage Airbag.

3. Includes

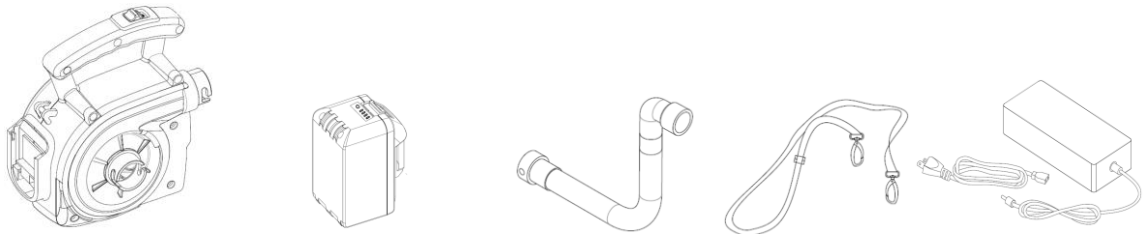

① Inflator x1 ② Lithium Battery x1 ③ Flexible Hose x1 ④ Strapx1 ⑤ Charger x1

4. Parts List

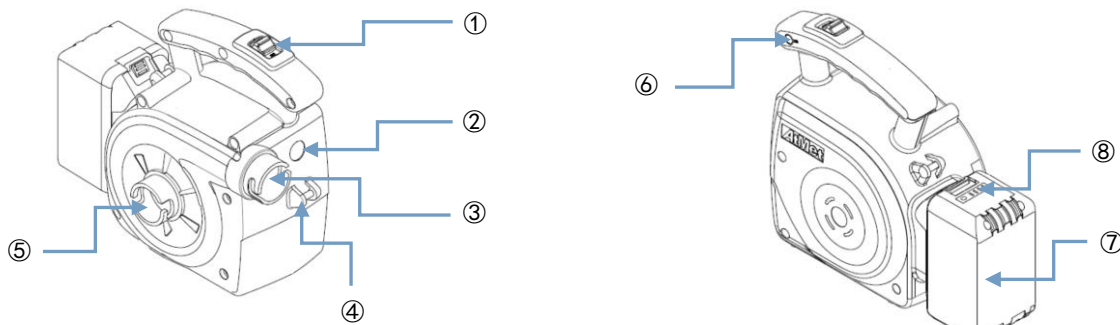

①: Switch ②: LED Light ③: Inflation port ④: Strap holder
 ⑤: Deflation port ⑥: LED Switch ⑦: Battery ⑧: Battery Level Indicator

5. Technical Parameters

Weight (kg Include Battery)	Air Flow (m ³ /h)	Battery voltage/ capacity	Recharging time (h)
2.45	70	24V/5.2Ah	4

6. Operating Instructions

Installation and Inflation

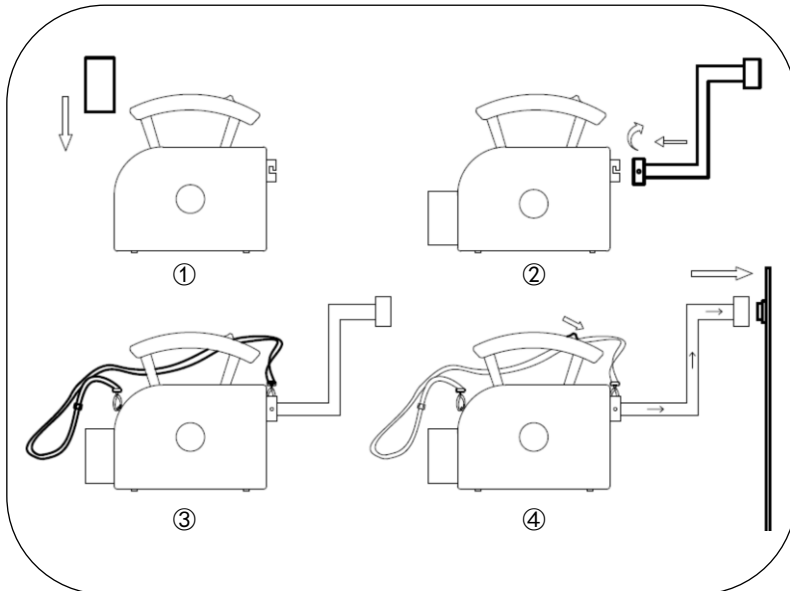

Reminder of completion of inflation

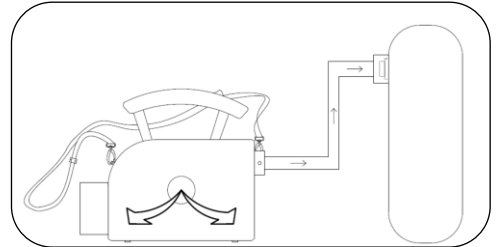

Disconnect the valve from the bag then turn off the inflator

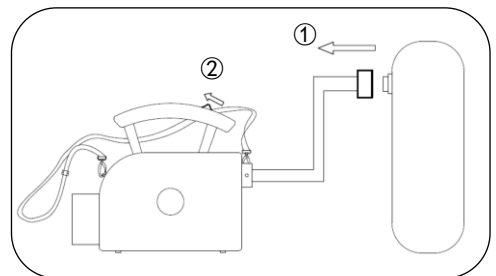

Deflation

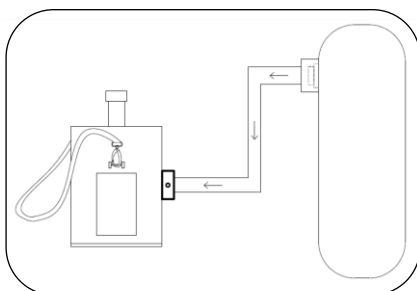

Lighting

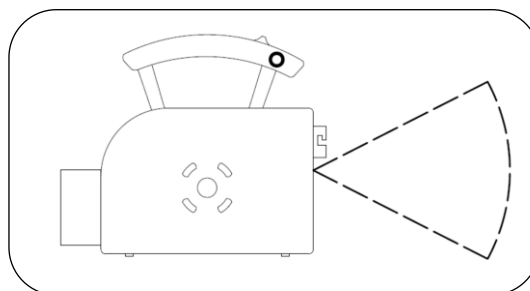

Inflator head can be held by the strap

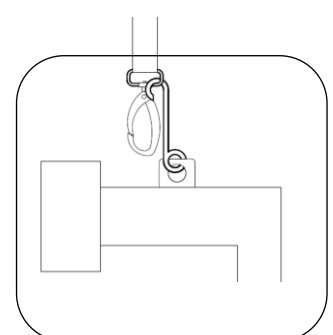

Power Display

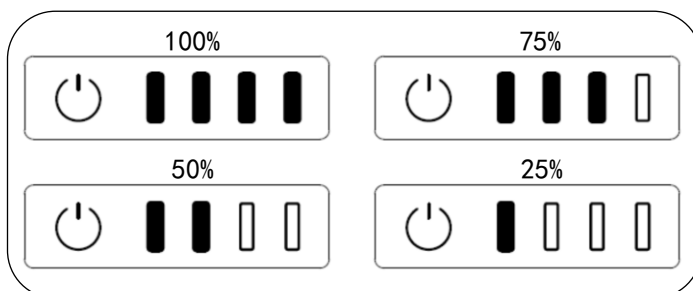

Charger

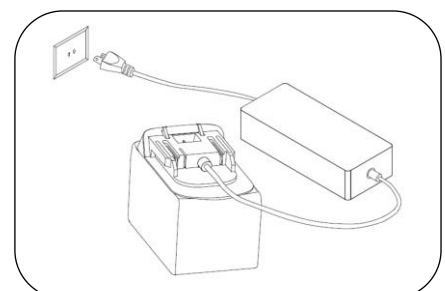

7. Important safety notes

1. Ensure that battery and inflator are properly connected before each use.
2. Before operating, check your battery level.
3. Disconnect the battery and turn off LED light when inflator is not in use.
4. Do not operate your inflator in rainy environment.
5. The air vents must never be blocked during inflating.